Comfort-Cire® **Century**®

SE Series

Single-Stage Multi-Position Gas Furnace
80%

GFM80S040A3S1A

Parts List



MARS®

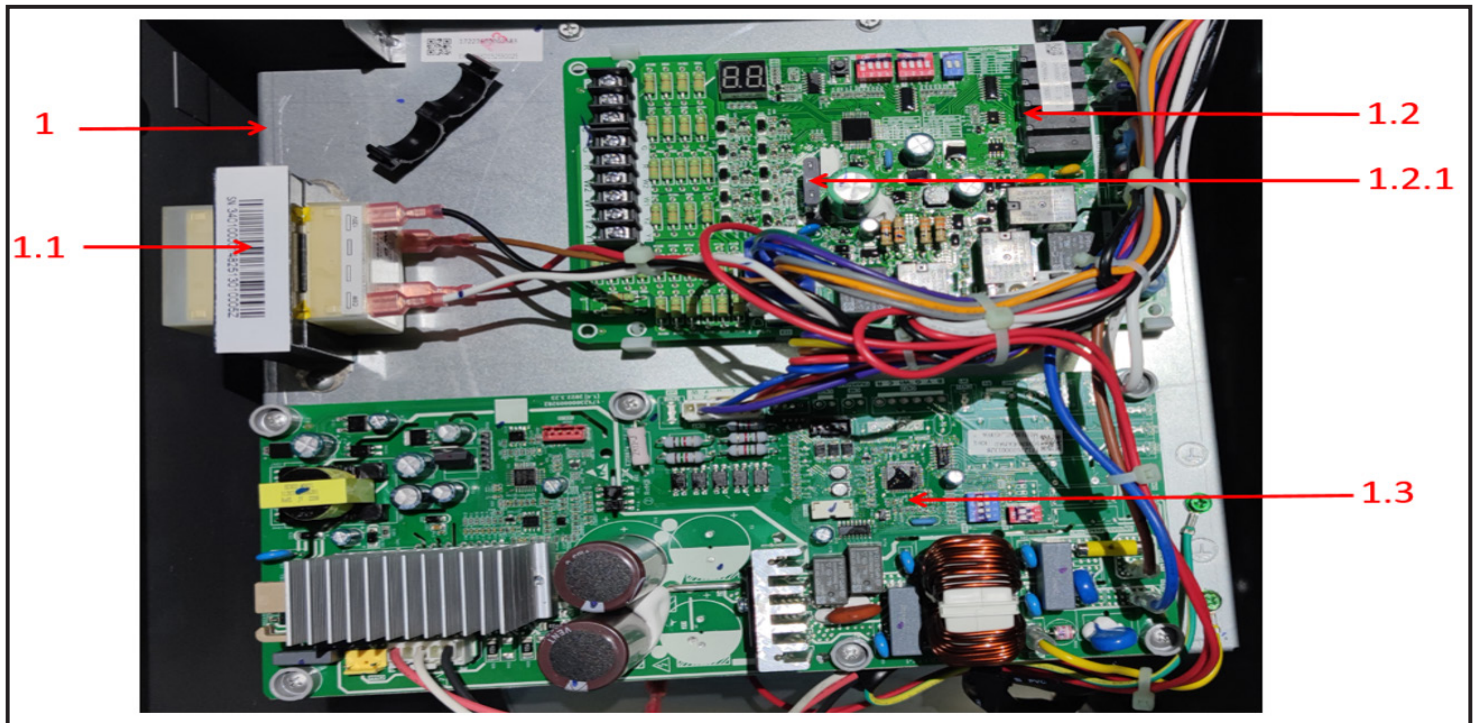
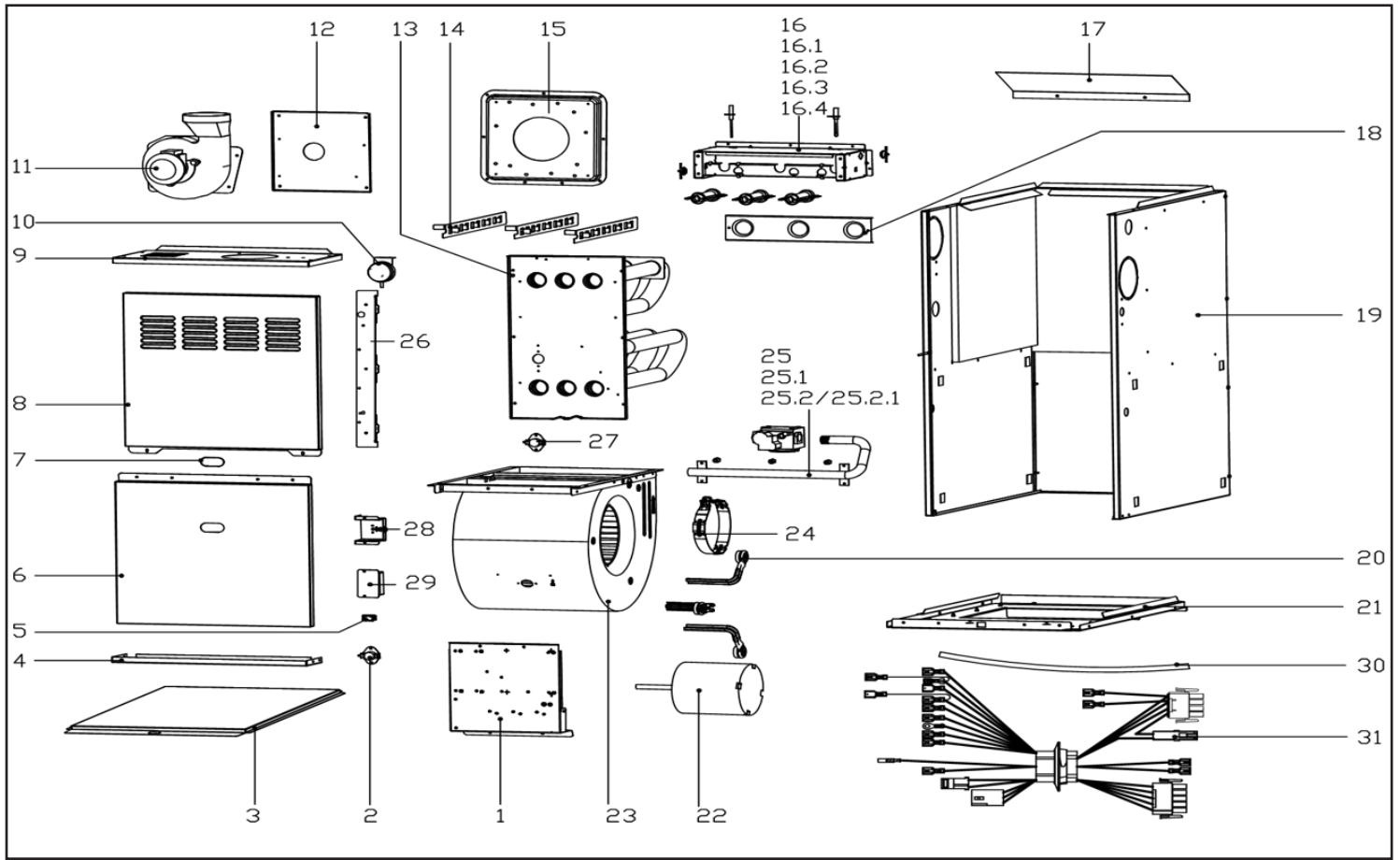

EX_ID	Spare Parts Code	Part Name(EN)	Qty.	Recommend store spare parts
1	17227600001583	E-part box assembly	1	
1.1	11203103000197	Linear Transformer	1	YES
1.2	17127600000708	Tie-in assembly of main control board	1	
1.2.1	11203001001353	Fuse	1	YES
1.3	17127600A00062	Gas furnace, Main control board assembly	1	YES
2	17400513002815	Temperature switch	1	YES
3	12227600000103	Sealing plate	1	
4	12227600002723	Support plate assembly	1	
5	17427600001148	Door switch	1	YES
6	12227600002445	Cover	1	
7	12127600000009	Plastic cover	1	
8	12227600002448	Cover	1	
9	12227600002446	Cover assembly	1	
10	17400515000421	Air switch	1	YES
11	17400801000223	Exhaust fan ass'y	1	YES
12	12227600000011	Exhaust baffles	1	
13	15727600000008	Heat-exchanger ass'y	1	
14	12227600000058	Spoiler	3	
15	12227600000236	Gas-collecting hood	1	
16	12227600002762	Burner Components	1	
16.1	11201006000010	Special sensor	1	YES
16.2	17427600000007	Firing pin	1	YES
16.3	17400513000045	Thermostat	2	YES
16.4	17427600000005	Burner	3	
17	12227600000019	Damper, air channel	1	
18	12227600000229	Deflector	1	
19	12227600002444	Cabinet Components	1	
20	12223000001934	Motor bracket ass'y I	3	
21	12227600000216	Partition board ass'y	1	
22	11002015016399	Brushless DC Motor	1	YES
23	12200102000019	Centrifugal fan	1	YES
24	12223000001992	Supporter of fan motor	1	
25	15427600000105	Gas Components	1	
25.1	17427600001389	Gas Valve	1	YES
25.2	15427600000100	Gas Components	1	
25.2.1	15527600000292	Copper nozzle	3	YES
26	12227600002720	Support plate assembly	2	
27	17400513003815	Temperature switch	1	YES
28	12227600000818	Junction box	1	
29	12227600000817	Junction box cover	1	
30	12627600000008	Silicone tube	1	
31	17401203023509	Strong electric cable group	1	

Due to ongoing product improvements, specifications and dimensions are subject to change and correction without notice or incurring obligations. Determining the application and suitability for use of any product is the responsibility of the installer. Additionally, the installer is responsible for verifying dimensional data on the actual product prior to beginning any installation preparations.

Incentive and rebate programs have precise requirements as to product performance and certification. All products meet applicable regulations in effect on date of manufacture; however, certifications are not necessarily granted for the life of a product. Therefore, it is the responsibility of the applicant to determine whether a specific model qualifies for these incentive/rebate programs.



1900 Wellworth Ave., Jackson, MI 49203 • Ph. 517-787-2100 • www.marsdelivers.com

